

 **breviglieri**

## **MULCHERS / SHREDDERS**

TRINCIATRICI / BROYEURS  
MULCHER / TRITURADORAS

## **GARDENING**

GIARDINAGGIO / JARDINAGE  
GARTEN / JARDINERIA

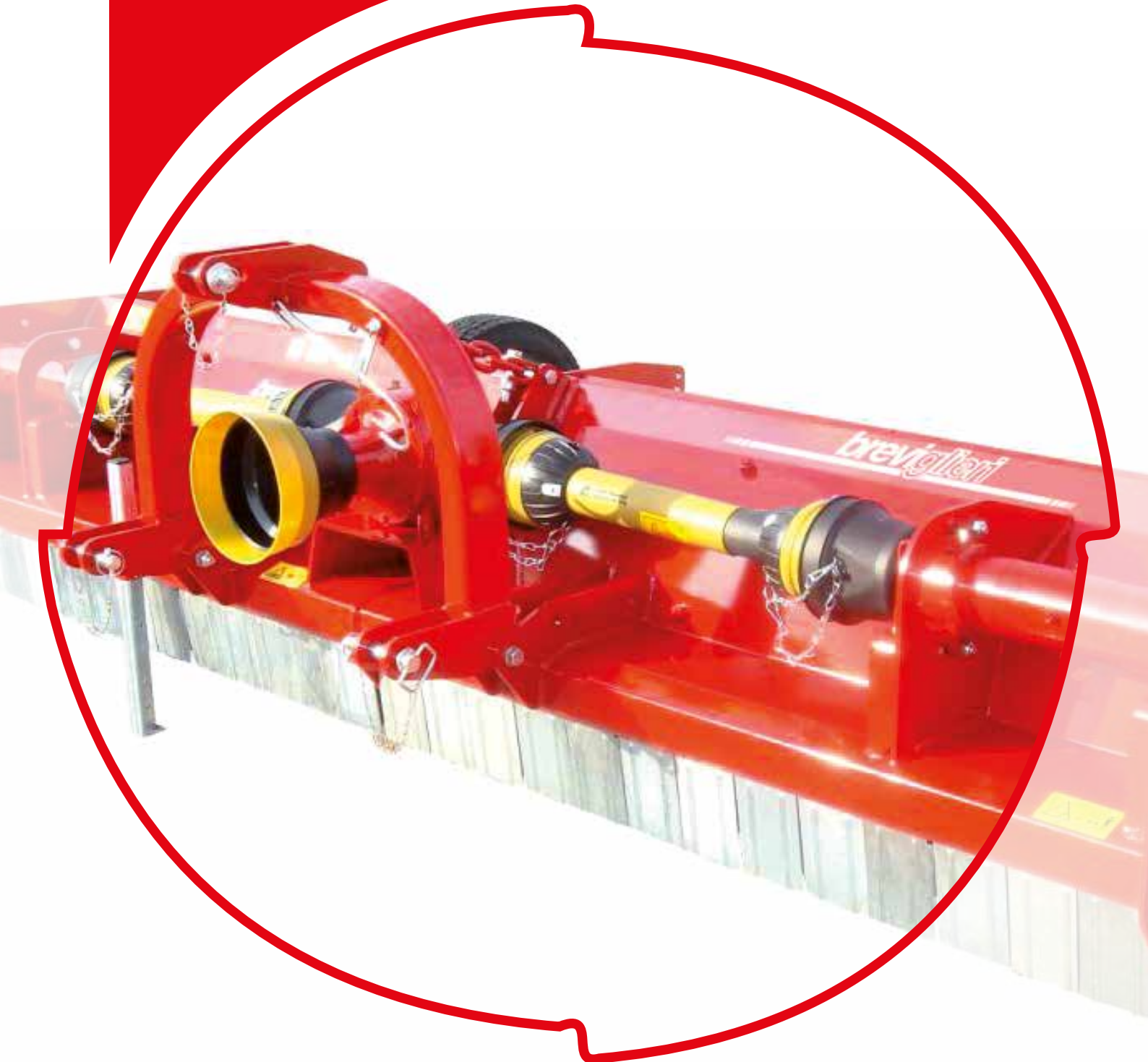

 **breviglieri**

Uomini, idee, macchine.



# GARDEN *Line*

● Giardinaggio ● Jardinage ● Garten ● Jardineria

## Jet 50 SR

**15 - 40 HP**  
cm. 105 - 125 - 155



## Mini Storm

**20 - 40 HP**  
cm. 120 - 150 - 180 - 210



## Green Storm

**20 - 40 HP**  
cm. 120 - 150 - 180



# The range

Available for tractors from 20 up to 220 HP

- I Disponibili per trattori da 20 a 220 cv
- F Disponibles pour tracteurs de 20 à 220 cv
- D Verfügbar für Traktoren von 20 bis 220 PS
- E Disponibles para tractores de 20 a 220 cv

I La gamma F La gamme D Die Auswahl E La gama

## Turbo T 51 SR



**20 - 50 HP**  
cm. 105 - 125 - 155 - 180 - 200

## Turbo T 76 SR



**30 - 70 HP**  
cm. 105 - 125 - 140 - 155 - 180 - 200 - 220

## Turbo T 100/I 10 SR



**40 - 90 HP**  
cm. 155 - 180 - 200 - 220 / 250 - 280

## Turbo T 180 SR



**120 - 180 HP**  
cm. 280 - 300

## Turbo T 120 SR



**65 - 120 HP**  
cm. 180-200-220-250-280-300



## Hurricane H 82



**55 - 70 HP**  
cm. 160-200-230

## Hurricane H 102 DT

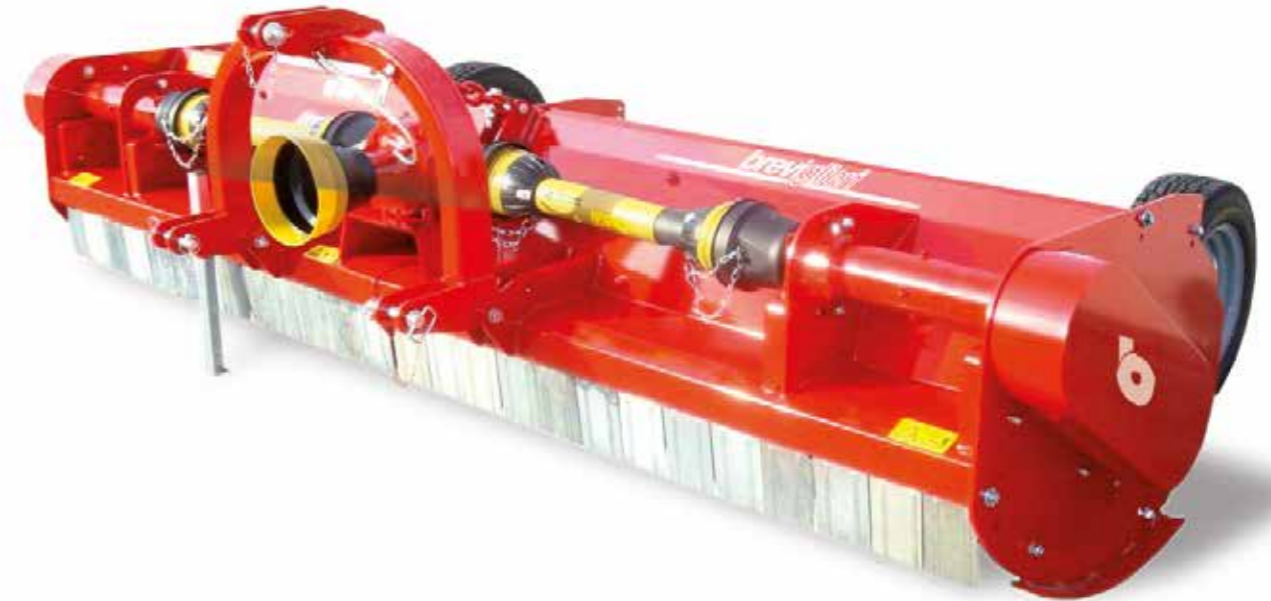

**115 - 180 HP**  
cm. 320 - 400

## Hurricane H 82 Plus



**70 - 100 HP**  
cm. 250-280

## Hurricane H 182 Fold



**140 - 220 HP**  
cm. 470-600

## Mini Master



**15 - 40 HP**  
cm. 120-150

## Hyper Master



**80 - 120 HP**  
cm. 180-200-220-250

## Hyper Master XL



## Master

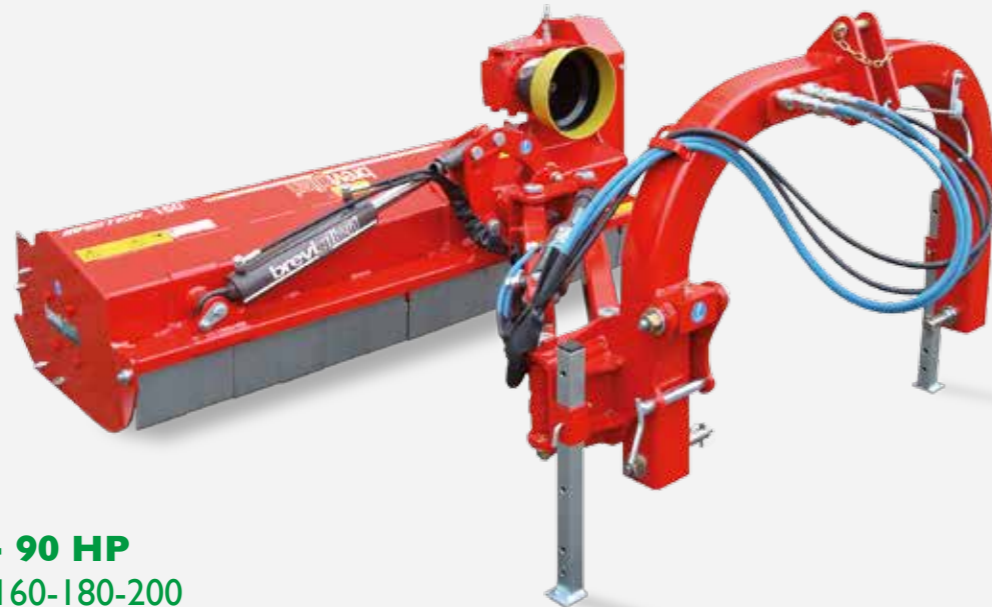

**40 - 90 HP**  
cm. 160-180-200

## Super Master



## Shift Master L



**35 - 45 HP**  
cm. 120-150

## Shift Master XL

**60 - 160 HP**  
cm. 140-160-180-200-220-250

## SIDE TRASMISSION

1 TRASMISSIONE LATERALE 2 TRANSMISSION LATÉRALE 3 SEITLICHE ANTRIEB 4 TRASMISIÓN LATERAL



JET 50 SR	N° 2	XPA 1000
TURBOT 51 SR	N° 3	XPB 1180
TURBOT 76 SR (105-155)	N° 3	SPBX 1250
TURBOT 76 SR (180-220)	N° 4	SPBX 1250
TURBOT 100 SR	N° 4	SPBX 1340
TURBOT 110 SR	N° 5	SPBX 1340
TURBOT 120 SR (180-220)	N° 4	SPBX 1600
TURBOT 120 SR (250-300)	N° 5	SPBX 1600
TURBOT 180 SR	N° 5	SPBX 1900
HURRICANE H 82	N° 4	SPBX 1600
HURRICANE H 82 PLUS	N° 5	SPBX 1600
HURRICANE H 102 DT	N° 4+4	SPBX 1600
HURRICANE H 182 FOLD	N° 5+5	SPB 1750
MINI MASTER	N° 3	SPB 1250
MASTER - SUPER MASTER	N° 4	SPBX 1400
HYPER MASTER - HYPER MASTER XL	N° 4	SPBX 1510
SHIFT MASTER L	N° 3	XPB 1900
SHIFT MASTER XL	N° 4	XPB 2900

## GEARBOX

1 SCATOLA INGRANAGGI 2 BOÎTIER 3 GETRIEBE 4 CAJA ENGRANAJES

STANDARD VERSION / VERSIONE STANDARD / VERSION STANDARD / STANDARDVERSION / VERSION ESTANDAR



### WITH FREE WHEEL

1 CON RUOTA LIBERA 2 AVEC ROUE LIBRE  
3 MIT FREILAUF 4 CON RUEDA LIBRE

JET 50 SR  
TURBOT 51 SR  
TURBOT 76 SR  
TURBOT 100/110 SR  
TURBOT 120 SR  
TURBOT 180 SR  
HURRICANE H 82  
HURRICANE H 82 PLUS  
HURRICANE H 102 DT

MINI MASTER  
MASTER  
SUPER MASTER  
HYPER MASTER  
HYPER MASTER XL  
SHIFT MASTER L  
SHIFT MASTER XL

### WITHOUT FREE WHEEL

1 WITHOUT FREE WHEEL 2 SANS ROUE LIBRE  
3 OHNE FREILAUF 4 SIN RUEDA LIBRE

HURRICANE H 182 FOLD



### REAR PTO

1 PDF POSTERIORE 2 PDF ARRIÈRE  
3 HINTERE DURCHTRIEB 4 TDF TRASERA

JET 50 SR  
TURBOT 51 SR  
TURBOT 76 SR  
TURBOT 100/110 SR  
TURBOT 120 SR  
TURBOT 180 SR

## ROTORS

1 ROTORI 2 ROTORS 3 ROTOREN 4 ROTORES



### ONLY ON:

1 SOLAMENTE PER 2 SEULEMENT POUR  
3 NÜR FÜR 4 SOLAMENTE POR

TURBOT 180 SR

JET 50 SR	Ø 102 mm X 6 mm
TURBOT 51 SR	Ø 127 mm X 8 mm
TURBOT 76 SR (105-140)	Ø 139,7 mm X 7 mm
TURBOT 76 SR (155-220)	Ø 139,7 mm X 10 mm
TURBOT 100 SR	Ø 168,3 mm X 10 mm
TURBOT 110 SR	Ø 168,3 mm X 10 mm
TURBOT 120 SR (180-250)	Ø 193,7 mm X 10 mm
TURBOT 120 SR (280-300)	Ø 193,7 mm X 12,5 mm
TURBOT 180 SR	Ø 193,7 mm X 12,5 mm
HURRICANE H 82	Ø 168,3 mm X 10 mm
HURRICANE H 82 PLUS (250)	Ø 193,7 mm X 10 mm
HURRICANE H 82 PLUS (280)	Ø 193,7 mm X 12,5 mm
HURRICANE H 102 DT (N.2)	Ø 193,7 mm X 10 mm
HURRICANE H 182 FOLD (N.2)	Ø 193,7 mm X 12,5 mm
MINI MASTER 120	Ø 89 mm X 6,3 mm
MINI MASTER 150	Ø 108 mm X 8 mm
MASTER	Ø 159 mm X 8 mm
SUPER MASTER	Ø 159 mm X 8 mm
HYPER MASTER	Ø 193,7 mm X 10 mm
HYPER MASTER XL	Ø 193,7 mm X 10 mm
SHIFT MASTER L	Ø 108 mm X 6,3 mm
SHIFT MASTER XL	Ø 159 mm X 10 mm
SHIFT MASTER XL / 250	Ø 159 mm x 12,5 mm

### ALL THE RANGE WITH BELTS TRANSMISSION ADJUSTMENT

1 TUTTA LA GAMMA DI TRINCIATRICI È CON LA REGOLAZIONE DELLE CINGHIE DI TRASMISSIONE 2 GAMME COMPLETE AVEC RÉGLAGE COURROIES DE TRANSMISSION  
3 STANDARD AUSSTATTUNG MIT KEILRIEMEN VERSTELLUNG 4 GAMA COMPLETA DE TRITURADORAS CON REGULACION CORREAS DE TRANSMISSION LATERAL

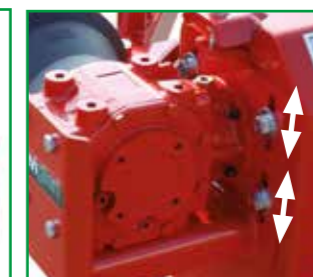

## HAMMERS / BLADES

1 MAZZE E COLTELLI 2 MARTEAUX / COUTEAUX 3 HAMMERSCHLEGEL / MESSER 4 MARTILLOS / CUCHILLAS

**JET 50 SR**



REF 30

**TURBOT 51 SR**



REF 40



REF 50

**TURBO T 76 SR**



REF 40



REF 50

**TURBO T 100 / 110 SR**



REF 40



REF 50

**TURBO T 120 SR**



REF 60



REF 50

**TURBOT 180 SR**



REF 240

Option: T 76 SR / T 100 SR

**HURRICANE H 82 / H 82 PLUS / H 102 DT**



REF 110



REF 100



REF 90



REF 80

**HURRICANE 182 FOLD**



REF 160



REF 170

**MINI - MASTER**



REF 180



REF 190

**MASTER - SUPER MASTER**



REF 40



REF 50

**HYPHER MASTER - HYPHER MASTER XL**



REF 120

**SHIFT MASTER L**



REF 200



REF 220

**SHIFT MASTER XL**



REF 210



REF 230

## COUNTER BLADES

1 CONTRO COLTELLO 2 CONTRE - COUTEAU 3 GEGENMESSER 4 CONTRA CUCHILLA



### STANDARD

JET 50 SR N° 1  
 TURBO T 51 SR N° 2  
 TURBO T 76 SR N° 2  
 TURBO T 100/110 SR N° 2  
 TURBO T 120 SR N° 2  
 TURBO T 180 SR N° 2



### STANDARD

HURRICANE H 82 N° 1  
 HURRICANE H 82 PLUS N° 1  
 HURRICANE H 102 DT N° 1  
 HURRICANE H 182 FOLD N° 2  
 MINI MASTER N° 2  
 MASTER N° 2  
 HYPER MASTER (XL) N° 2

### OPTION

N° 1  
 N° 1  
 N° 1  
 N° 1

## FRONT PROTECTIONS

1 PROTEZIONI FRONTALI 2 PROTECTIONS FRONTALES 3 VORDERESCHUTZE 4 PROTECCIONES DELANTERAS



### STANDARD

ALL THE MODELS

1 TUTTI I MODELLI 2 TOUS LES MODÈLES 3 ALLE MODELLE 4 TODOS LOS MODELOS



### STANDARD

TURBOT 180 SR

### OPTION

TURBO: T 76 SR - T 100/110 SR - T 120 SR  
 HURRICANE: H 82 - H 82 PLUS - H 102 DT  
 MASTER (SUPER) - HYPER MASTER (XL)

## DOUBLE FRAME

1 DOPPIO TELAIO 2 DOUBLE CHASSIS 3 GESCHWEISST GEGENRAHMEN 4 DOUBLE BASTIDOR

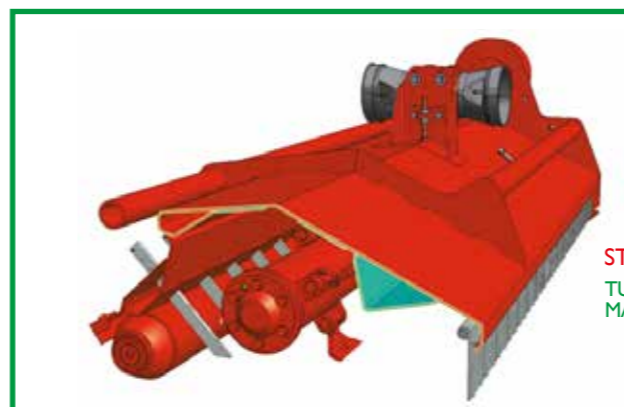

### STANDARD

TURBO: T 76 SR - T 100/110 SR - T 120 SR - T 180 SR  
 MASTER (SUPER MASTER) - HYPER MASTER (XL) - SHIFT MASTER XL



## CUTTING HEIGHT ADJUSTMENT

REGOLAZIONE ALTEZZA DI TAGLIO / RÉGLAGE HAUTEUR DE COUPE / SCHNITTHÖHEEINSTELLUNG / REGULACION ALTURA DE CORTE

## ROLLERS

ROLLERS / ROULEAUX / WALZEN / RODILLOS

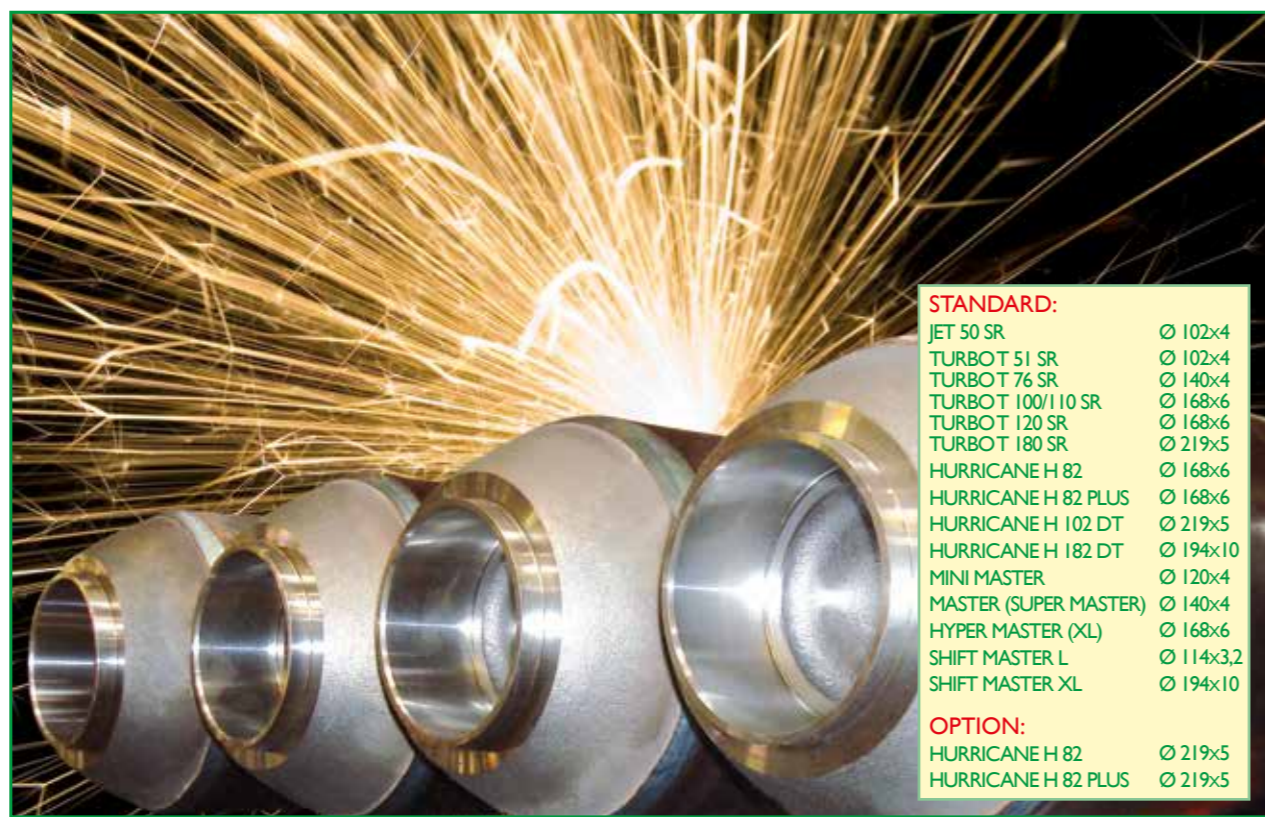

STANDARD:	
JET 50 SR	Ø 102x4
TURBOT 51 SR	Ø 102x4
TURBOT 76 SR	Ø 140x4
TURBOT 100/110 SR	Ø 168x6
TURBOT 120 SR	Ø 168x6
TURBOT 180 SR	Ø 219x5
HURRICANE H 82	Ø 168x6
HURRICANE H 82 PLUS	Ø 168x6
HURRICANE H 102 DT	Ø 219x5
HURRICANE H 182 DT	Ø 194x10
MINI MASTER	Ø 120x4
MASTER (SUPER MASTER)	Ø 140x4
HYPER MASTER (XL)	Ø 168x6
SHIFT MASTER L	Ø 114x3,2
SHIFT MASTER XL	Ø 194x10
OPTION:	
HURRICANE H 82	Ø 219x5
HURRICANE H 82 PLUS	Ø 219x5

## SIDE SKIDS

SLITTE LATERALI / PATINS LATÉRAUX / SEITLICHE KUFEN / PATINES LATÉRALES

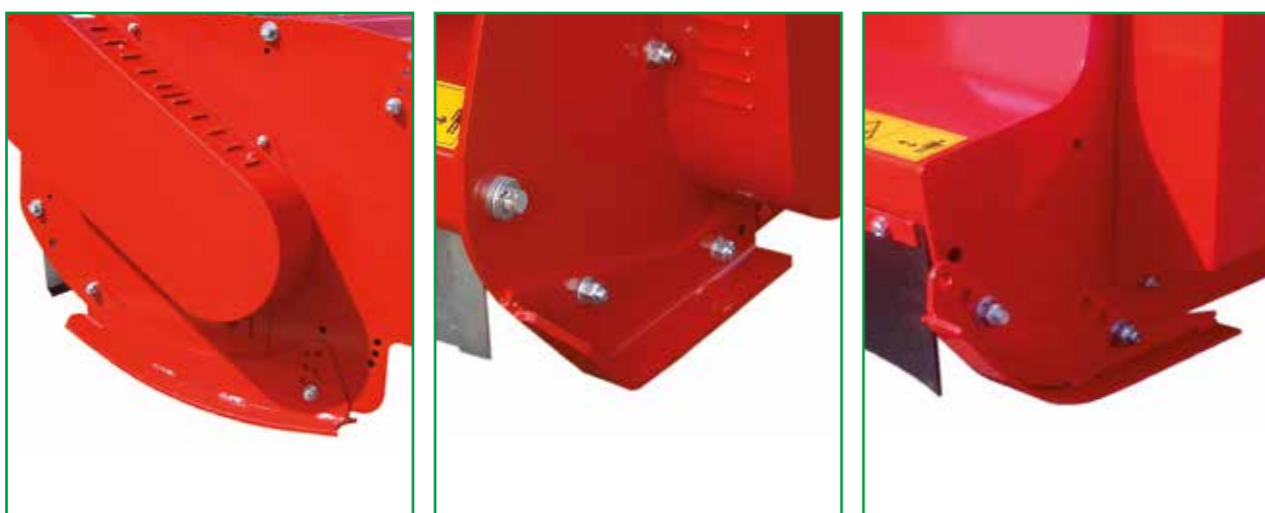

**STANDARD**  
JET 50 SR  
TURBOT 51 SR  
TURBOT 76 SR  
TURBOT 100/110 SR  
TURBOT 180 SR

**OPTION**  
HURRICANE H 82  
HURRICANE H 82 PLUS  
HURRICANE H 102 DT  
MASTER (SUPER MASTER)  
HYPER MASTER (XL)

## PAIR OF REAR WHEELS

COPPIA RUOTE POSTERIORE / PAIRE DE ROUES ARRIÈRE / ZWEI HINTERE RÄDER / 2 RUEDAS TRASERA



**OPTION**  
HURRICANE H 82  
HURRICANE H 82 PLUS  
HURRICANE H 102 DT  
HURRICANE H 182 FOLD



**OPTION**  
HURRICANE H 82  
HURRICANE H 82 PLUS  
HURRICANE H 102 DT

## MECHANICAL (M) / HYDRAULIC (H) SIDE SHIFT

SPOSTAMENTO LATERALE MECCANICO/HIDRAULICO / DÉPORT LATÉRAL MÉCANIQUE/HYDRAULIQUE / MECHANISCHE/HYDRAULISCHE SEITENVERSCHIEBUNG / DESPLAZAMIENTO LATERAL MECÁNICO/HIDRAULICO

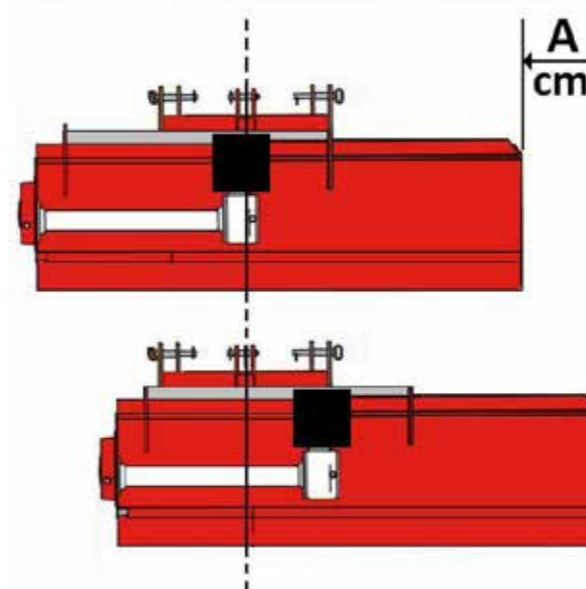

### STANDARD (M) MECHANICAL

MODEL	A
JET 50 SR	cm 15
TURBOT 51 SR 105 / 200	cm 40
TURBOT 76 SR 105 / 155	cm 30
TURBOT 76 SR 180 / 220	cm 40
TURBOT 100/110 SR	cm 40
TURBOT 120 SR	cm 40

### STANDARD (H) HYDRAULIC

MODEL	A
TURBOT 180 SR	cm 40

### OPTION (H) HYDRAULIC

MODEL	A
TURBOT 51 SR 105 / 125	cm 30
TURBOT 76 SR 105 / 155	cm 30
TURBOT 76 SR 180 / 220	cm 40
TURBOT 100/110 SR	cm 40
TURBOT 120 SR	cm 40

# ACCESSOIRES

ACCESSORI / ACCESSOIRES  
ZUBEHÖREN / EQUIPOS

## PTO SHAFT

I CARDANO F CARDAN D GELENKWELLE E CARDAN



WITHOUT SAFETY DEVICE  
I SENZA SICUREZZA  
F SANS SÉCURITÉ  
D OHNE SICHERHEIT  
E SIN SEGURIDAD

ALL THE RANGE  
I TUTTA LA GAMMA  
F TOUTE LA GAMME  
D ALLE MODELLE  
E TODA LA GAMA



DOUBLEWIDE - ANGLE  
I DOPPIO OMOCINETICO  
F DOUBLE HOMOCINETIQUE  
D DOPPEL WEITWINKEL  
E DOBLE HOMOCINETICO

MASTER / OPTION  
SUPER MASTER / OPTION  
HYPER MASTER / OPTION  
HYPER MASTER XL / OPTION

## COLLECTING RAKES

I ASTE DI RACCOLTA F TIGES DE RÉCOLTE  
D RECHEN E RASTRILLOS



OPTION  
TURBOT 76 SR - T 100/110 SR - T 120 SR

## HYDRAULIC SAFETY HOOK

I GANCI DI SICUREZZA IDRAULICI F CROCHETS DE SÉCURITÉ HYDR.  
D HYDR. SICHERHEITSHAKEN E GANCHOS DE SEGURIDAD HIDR.



OPTION  
HURRICANE H 182 FOLD

## REAR LIGHTS / BACK REFLEX PANELS

I LUCI POSTERIORI / PANNELLI RETRORIFLETTENT F DISPOSITIF D'ÉCLAIRAGE / PANNEAUX DE SIGNALISATION  
D BELEUCHTUNG / WARTAFELN E DISPOSITIVO DE ALUMBRADO / PANELO RETRORREFLEJANTES



STANDARD  
HURRICANE H 182 FOLD

# TECHNICAL DATA

DATITECNICI / DONNÉES TECHNIQUES  
TECHNISCHE DATEN / DATOSTECNICOS

MOD.	HP	RPM	540 1000	Kg.	N.	N.	N.	N.	Cm.
<b>JET 50 SR / 105</b>	15-25	540	-	160	2	60	-	-	2 - 6
<b>JET 50 SR / 125</b>	20-35	540	-	180	2	72	-	-	2 - 6
<b>JET 50 SR / 155</b>	30-40	540	-	200	2	90	-	-	2 - 6
<b>TURBO T 51 SR / 105</b>	20-30	540	-	260	3	-	30-10	-	2 - 5
<b>TURBO T 51 SR / 125</b>	25-35	540	-	285	3	-	36-12	-	2 - 5
<b>TURBO T 51 SR / 155</b>	25-40	540	-	320	3	-	48-16	-	2 - 5
<b>TURBO T 51 SR / 180</b>	30-45	540	-	355	3	-	54-18	-	2 - 5
<b>TURBO T 51 SR / 200</b>	35-50	540	-	390	3	-	60-20	-	2 - 5
<b>TURBO T 76 SR / 105</b>	30-50	-	540/1000	435	3	-	24-08	-	2 - 7
<b>TURBO T 76 SR / 125</b>	35-55	-	540/1000	450	3	-	30-10	-	2 - 7
<b>TURBO T 76 SR / 140</b>	40-60	-	540/1000	465	3	-	36-12	-	2 - 7
<b>TURBO T 76 SR / 155</b>	45-65	-	540/1000	495	3	-	42-14	-	2 - 7
<b>TURBO T 76 SR / 180</b>	45-65	-	540/1000	530	4	-	48-16	-	2 - 7
<b>TURBO T 76 SR / 200</b>	50-70	-	540/1000	575	4	-	54-18	-	2 - 7
<b>TURBO T 76 SR / 220</b>	50-70	-	540/1000	620	4	-	60-20	-	2 - 7
<b>TURBO T 100 SR / 155</b>	40-60	-	540/1000	690	4	-	42-14	-	2 - 7
<b>TURBO T 100 SR / 180</b>	45-65	-	540/1000	750	4	-	48-16	-	2 - 7
<b>TURBO T 100 SR / 200</b>	45-70	-	540/1000	790	4	-	54-18	-	2 - 7
<b>TURBO T 100 SR / 220</b>	50-75	-	540/1000	840	4	-	60-20	-	2 - 7
<b>TURBO T 110 SR / 250</b>	55-80	-	540/1000	910	5	-	66-22	-	2 - 7
<b>TURBO T 110 SR / 280</b>	60-90	-	540/1000	980	5	-	72-24	-	2 - 7
			opt. - OPTION						
<b>TURBO T 120 SR / 180</b>	65-80	540	1000 opt.	800	4	-	-	48-16	2 - 7
<b>TURBO T 120 SR / 200</b>	75-90	540	1000 opt.	850	4	-	-	54-18	2 - 7
<b>TURBO T 120 SR / 220</b>	80-95	540	1000 opt.	900	5	-	-	60-20	2 - 7
<b>TURBO T 120 SR / 250</b>	95-110	540	1000 opt.	970	5	-	-	66-22	2 - 7
<b>TURBO T 120 SR / 280</b>	100-120	540	1000 opt.	1080	5	-	-	72-24	2 - 7
<b>TURBO T 120 SR / 300</b>	100-120	540	1000 opt.	1160	5	-	-	78-26	2 - 7

MOD.	HP	RPM	Kg.	N.	N.	Cm.
<b>TURBO T 180 SR / 280</b>	120-180	1000	1350	5	28	2 - 7
<b>TURBO T 180 SR / 300</b>	120-180	1000	1445	5	30	2 - 7

MOD.	HP	RPM	Kg.	N.	N.	N.	Cm.
<b>HURRICANE H 82 / 160</b>	55-60	540	640	4	32-48-16-32	-	2 - 7
<b>HURRICANE H 82 / 200</b>	60-65	540	680	4	40-60-20-40	-	2 - 7
<b>HURRICANE H 82 / 230</b>	65-70	540	700	4	44-66-22-44	-	2 - 7
<b>HURRICANE H 82 PLUS/250</b>	70-80	540	750	5	48-72-24-48	-	2 - 7
<b>HURRICANE H 82 PLUS/280</b>	80-90	540	820	5	56-84-28-56	-	2 - 7
<b>HURRICANE H 102 dt/320</b>	115-180	1000	1050	4+4	64-96-32-64	-	2 - 7
<b>HURRICANE H 102 dt/400</b>	115-180	1000	1300	4+4	80-120-40-80	-	2 - 7
<b>HURRICANE H 182 FOLD/475</b>	140-180	1000	2300	5+5	-	96-48	2 - 7
<b>HURRICANE H 182 PLUS/600</b>	150-220	1000	2800	5+5	-	128-64	2 - 7

## OFFSET ARM

1 SPOSTAMENTO IDRAULICO 2 DÉPORT HYDRAULIQUE 3 HYDRAULISCHE SEITENVERSCHIEBUNG 4 DESPLAZAMIENTO HIDRAULICO

• MINI MASTER • MASTER • SUPER MASTER • HYPER MASTER • HYPER MASTER XL • SHIFT MASTER L • SHIFT MASTER XL

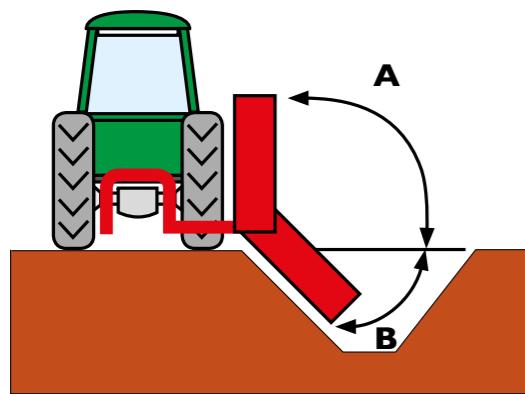

MODEL	A	B
MINI MASTER	90°	65°
MASTER	90°	60°
SUPER MASTER	90°	60°
HYPER MASTER	90°	60°
HYPER MASTER XL	90°	60°
SHIFT MASTER L	90°	65°
SHIFT MASTER XL	90°	65°

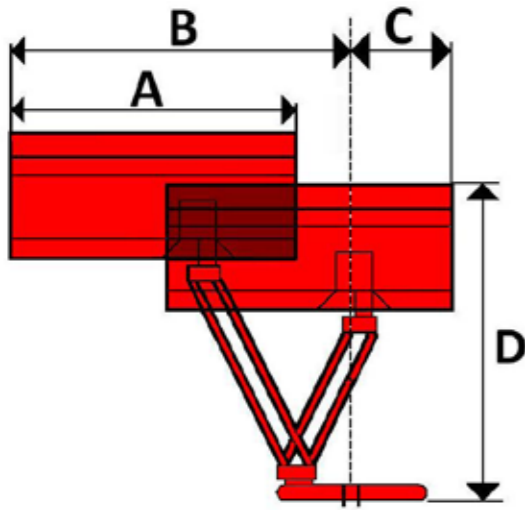

MODEL	A	B	C	D
MINI MASTER 120	cm 120	cm 220	cm 25	cm 130
MINI MASTER 150	cm 145	cm 265	cm 35	cm 140
MASTER 160	cm 162	cm 231	cm 58	cm 184
MASTER 180	cm 181	cm 250	cm 58	cm 184
MASTER 200	cm 200	cm 269	cm 58	cm 184
SUPER MASTER 160	cm 162	cm 266	cm 15	cm 184
SUPER MASTER 180	cm 181	cm 285	cm 15	cm 184
SUPER MASTER 200	cm 200	cm 304	cm 15	cm 184
HYPER MASTER 180	cm 182	cm 255	cm 60	cm 185
HYPER MASTER 200	cm 200	cm 273	cm 60	cm 185
HYPER MASTER 220	cm 219	cm 292	cm 60	cm 185
HYPER MASTER 250	cm 249	cm 322	cm 60	cm 185
HYPER MASTER XL 180	cm 182	cm 306	cm 10	cm 185
HYPER MASTER XL 200	cm 200	cm 324	cm 10	cm 185
HYPER MASTER XL 220	cm 219	cm 343	cm 10	cm 185
HYPER MASTER XL 250	cm 249	cm 373	cm 10	cm 185

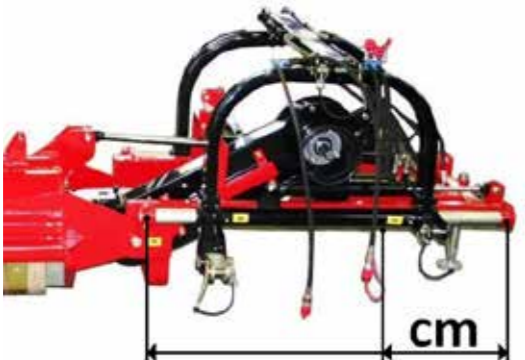

MODEL	
SHIFT MASTER L 80	cm 35
SHIFT MASTER L 100	cm 35
SHIFT MASTER L 120	cm 35
SHIFT MASTER L 140	cm 35
SHIFT MASTER XL 140	cm 55
SHIFT MASTER XL 160	cm 55
SHIFT MASTER XL 180	cm 55
SHIFT MASTER XL 200	cm 55
SHIFT MASTER XL 220	cm 55
SHIFT MASTER XL 250	cm 55

MOD.	HP	RPM	Kg.	N.	N.	N.	N.	Cm.
<b>MINI MASTER 120</b>	25 min.	540	196	3	48	-	-	2 - 6
<b>MINI MASTER 150</b>	25 min.	540	244	3	56	-	-	2 - 6
<b>MASTER 160</b>	40-70	540	550	4	-	42-14	-	2 - 7
<b>MASTER 180</b>	50-80	540	580	4	-	18-16	-	2 - 7
<b>MASTER 200</b>	60-90	540	610	4	-	54-18	-	2 - 7
<b>SUPER MASTER 160</b>	40-70	540	550	4	-	42-14	-	2 - 7
<b>SUPER MASTER 180</b>	50-80	540	580	4	-	18-16	-	2 - 7
<b>SUPER MASTER 200</b>	60-90	540	610	4	-	54-18	-	2 - 7
<b>HYPER MASTER 180</b>	80-90	540	810	4	-	-	16	2 - 7
<b>HYPER MASTER 200</b>	80-100	540	850	4	-	-	18	2 - 7
<b>HYPER MASTER 220</b>	90-110	540	890	4	-	-	20	2 - 7
<b>HYPER MASTER 250</b>	90-120	540	955	4	-	-	22	2 - 7
<b>HYPER MASTER XL 180</b>	80-90	540	830	4	-	-	16	2 - 7
<b>HYPER MASTER XL 200</b>	80-100	540	870	4	-	-	18	2 - 7
<b>HYPER MASTER XL 220</b>	90-110	540	910	4	-	-	20	2 - 7
<b>HYPER MASTER XL 250</b>	90-120	540	975	4	-	-	22	2 - 7

MOD.	HP	RPM	Kg.	N.	N.	N.	Cm.
<b>SHIFT MASTER L 120</b>	35-40	540	230	3	40-20	-	2-7
<b>SHIFT MASTER L 150</b>	40-45	540	340	3	48-24	-	2-7
<b>SHIFT MASTER XL 140</b>	60-70	540	780	4	-	24-12	2-7
<b>SHIFT MASTER XL 160</b>	70-80	540	830	4	-	28-14	2-7
<b>SHIFT MASTER XL 180</b>	85-90	540	880	4	-	28-14	2-7
<b>SHIFT MASTER XL 200</b>	90-100	540	930	4	-	32-16	2-7
<b>SHIFT MASTER XL 220</b>	100-120	540	980	4	-	36-18	2-7
<b>SHIFT MASTER XL 250</b>	120-160	540	1050	4	-	44-22	2-7





# GARDEN *Line*

## TECHNICAL SECTION

1 SEZIONE TECNICA 2 SECTION TECHNIQUE 3 TECHNISCHE SEITE 4 SECCION TECNICA

### BELT TRANSMISSION ADJUSTMENT

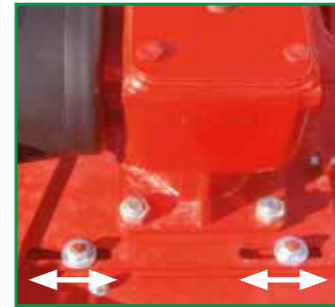

- 1 REGOLAZIONE CINGHIE DI TRASMISSIONE
- 2 RÉGLAGE TRANSMISSION DE COURROIES
- 3 KEILRIEMEN VERSTELLUNG
- 4 REGULACIÓN CORREAS DE TRANSMISSION

### PIVOTING WHEELS WITH HEIGHT ADJUSTMENT



- 1 RUOTE REGISTRABILI PER ALTEZZA DI TAGLIO
- 2 ROUES PIVOTANTES ET RÉGLABLES EN HAUTEUR
- 3 RÄDER FÜR SCHNITTHÖHEINSTELLUNG
- 4 RUEDAS PIVOTANTES Y AJUSTABLES EN ALTURA

### SIDE OR REAR DISCHARGE



- 1 SCARICO LATERALE
  - 2 EJECTION LAT. OU ARRIERE
  - 3 HINTER AUSWURF
  - 4 DESCARGO LATERAL O TRASERO
- MINI STORM
  - GREEN STORM

### KIT MULCHING



NOT AVAILABLE ON MINI STORM 210 REAR DISCHARGE  
 1 NON DISPONIBILE PER IL MINI STORM 210 SCARICO POSTERIORE  
 2 PAS DISPONIBLE POUR MINI STORM 210 AVEC EJECTION ARRIERE  
 3 NICHTVERFÜGBAR FÜR MINISTORM 210 HINTERE AUSWURF  
 4 NO DISPONIBLE POR MINI STORM 210 DESCARGO TRASERO

### WHEELS



- 1 RUOTE
  - 2 ROUES
  - 3 RÄDER
  - 4 RUEDAS
- MINI STORM  
N. 4 X Ø 210 mm
  - GREEN STORM  
N. 4 X Ø 240 mm

MOD.	CV	RPM	L	KG	N.	CM
MINI STORM 120	20 - 30	540	165	4 - Ø 210	3	2 - 7
MINI STORM 150	25 - 35	540	185	4 - Ø 210	3	2 - 7
MINI STORM 180	35 - 40	540	215	4 - Ø 210	3	2 - 7
MINI STORM 210	35 - 40	540	245	4 - Ø 210	3	2 - 7
GREEN STORM 120	20 - 30	540	180	4 - Ø 250	3	2 - 7
GREEN STORM 150	25 - 35	540	200	4 - Ø 250	3	2 - 7
GREEN STORM 180	35 - 40	540	230	4 - Ø 250	3	2 - 7



 **breviglieri**